

TULIP ACCESSORI

	Peso (Kg) Weight (Kg) Gewicht (Kg) Poids (Kg)	(LxHxP)	Imballi/Packaging/Verpackungen/Emballages
1	1,2	37x20x11	Mensola/Shelf/Ablage/Étagère 44x12x23
2	1,3	29x18x10	Portarotoli/Toilet-Paper holder/Toilettenpapierhalter/Porte rouleau 44x12x23
3	0,2	7x10,5x3	Appendino/Hook/Hacken/Crochet 20x7x10
4	0,4	33x7x4	Portasalviette/Towel rail/Handtuchhalter/Porte serviette 32x8x15
5	0,5	45x7x4	Portasalviette/Towel rail/Handtuchhalter/Porte serviette 44x8x15

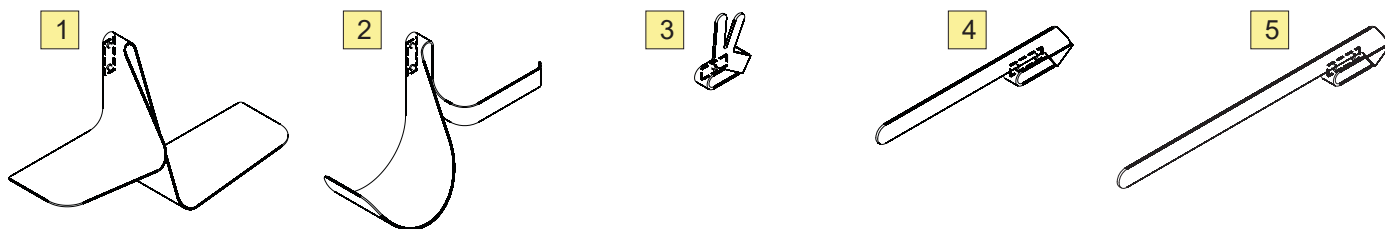
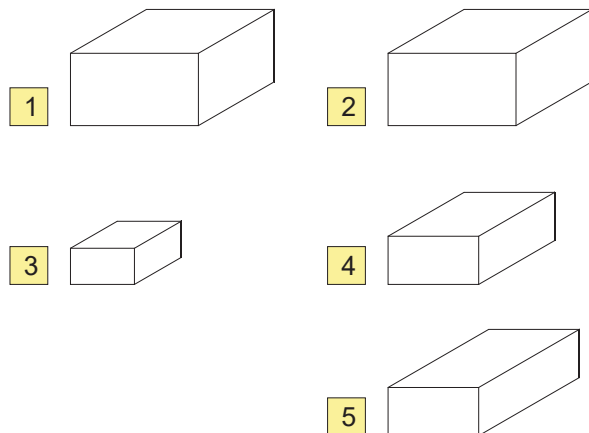

IT CARATTERISTICHE DIMENSIONALI
 GB DIMENSIONS CHARACTERISTICS
 D ABMESSUNGEN EIGENSCHAFTEN
 FR DIMENSIONNELS CARACTÉRISTIQUES

	IT	GB	D	FR		
1	Lunghezza Larghezza Altezza Peso netto Volume	Lenght Width Height Net weight Volume	Länge Breite Höhe Nettogewicht Volumen	Longueur Largueur Hauteur Poids net Volume	cm. cm. cm. kg. m ³	37 11 20 1,0 0,008
2	Lunghezza Larghezza Altezza Peso netto Volume	Lenght Width Height Net weight Volume	Länge Breite Höhe Nettogewicht Volumen	Longueur Largueur Hauteur Poids net Volume	cm. cm. cm. kg. m ³	29 10 18 1,1 0,006
3	Lunghezza Larghezza Altezza Peso netto Volume	Lenght Width Height Net weight Volume	Länge Breite Höhe Nettogewicht Volumen	Longueur Largueur Hauteur Poids net Volume	cm. cm. cm. kg. m ³	7 3 10,5 0,15 0,0002
4	Lunghezza Larghezza Altezza Peso netto Volume	Lenght Width Height Net weight Volume	Länge Breite Höhe Nettogewicht Volumen	Longueur Largueur Hauteur Poids net Volume	cm. cm. cm. kg. m ³	33 4 7 0,3 0,0009
5	Lunghezza Larghezza Altezza Peso netto Volume	Lenght Width Height Net weight Volume	Länge Breite Höhe Nettogewicht Volumen	Longueur Largueur Hauteur Poids net Volume	cm. cm. cm. kg. m ³	45 4 7 0,4 0,0012

IT CARATTERISTICHE DIMENSIONALI GE DIMENSIONS CHARACTERISTICS D ABMESSUNGEN EIGENSCHAFTEN FR DIMENSIONNELS CARACTÉRISTIQUES

- IT Le misure sono espresse in cm.
- GB All measurements are in centimetres.
- D Abmessungen in Zentimeters (cm).
- FR Les mesures sont exprimées en centimètre.

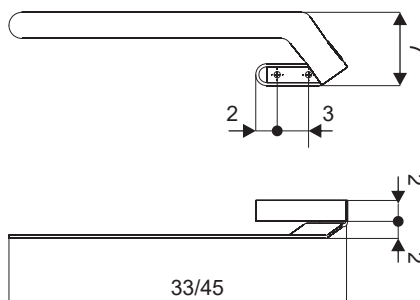
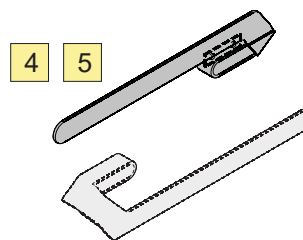
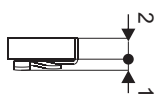
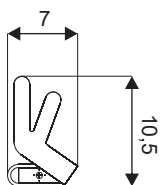
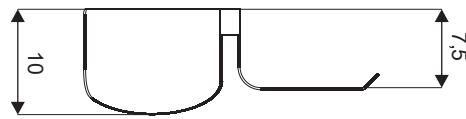
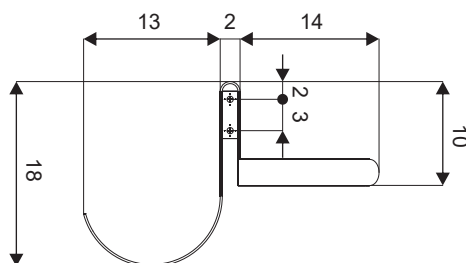
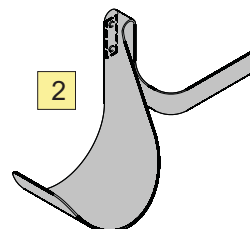
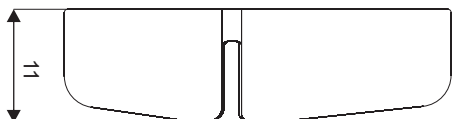
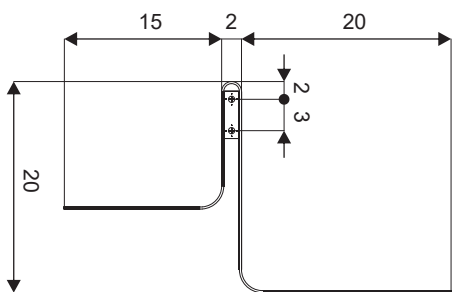
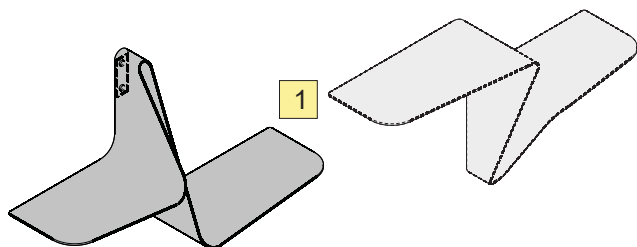

- IT Il costruttore si riserva il diritto di apportare modifiche al prodotto senza dare alcun preavviso.
- GB The manufacture reserves the right to modify the product at any time without prior notice.
- D Die Herstellerfirma behält sich das Recht vor, jederzeit und ohne vorherige Ankündigung Änderungen von technischen Angaben und Produkteigenschaften vorzunehmen.
- FR Le producteur se réserve le droit d'apporter des modifications au produit sans donner aucun préavis