

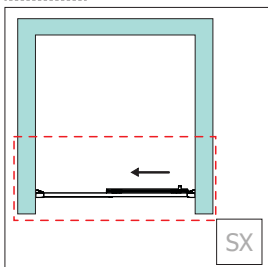

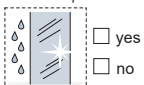

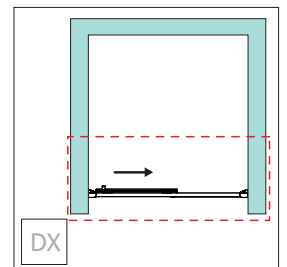





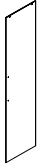

Trattamento protezione vetro
Shower Glass Protect
Glasschutzbehandlung
Traitement protection verre

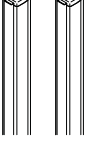
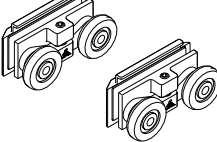
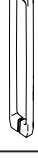
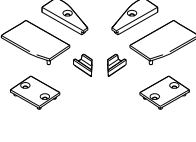
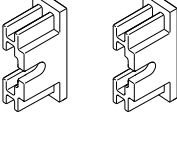

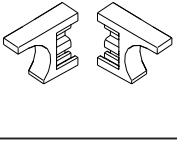
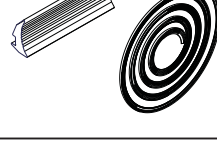
IT DIMENSIONE LATI:	GE SIDES MEASURES:	D SEITEN ABMESSUNGEN:	F DIMENSIONS CÔTE:
<input type="checkbox"/> 90	<input type="checkbox"/> 95	<input type="checkbox"/> 100	<input type="checkbox"/> 105
<input type="checkbox"/> 110	<input type="checkbox"/> 115	<input type="checkbox"/> 120	<input type="checkbox"/> 125
<input type="checkbox"/> 130	<input type="checkbox"/> 135	<input type="checkbox"/> 140	<input type="checkbox"/> 145
<input type="checkbox"/> 150	<input type="checkbox"/> 155	<input type="checkbox"/> 160	<input type="checkbox"/> 165
<input type="checkbox"/> 170	<input type="checkbox"/> F.M.		
IT PROFILO:	GE PROFILE:	D PROFIL:	F PROFIL:
<input type="checkbox"/> Argento Luc/Silver Brill/Silber Glanz/Argent brillant	<input type="checkbox"/> Bianco Seta/Silk White/Seide Weiss/Blanc Soie		
IT VETRO:	GE GLASS:	D GLAS:	F VERRE:
<input type="checkbox"/> Trasparente/Transparent	<input type="checkbox"/> Serigrafato/Serigraphy/Siebedruckt/Sérigraphié		

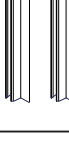
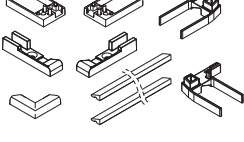
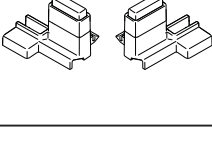





<p>R01 COD. RA300153</p> <ul style="list-style-type: none"> IT LATO FISSO "P" GB FIXED SIDE «P» D FIX TEIL «P» F CÔTE FIXE «P» 		<p>R02 COD. RA300154</p> <ul style="list-style-type: none"> IT ANTA SCORREVOLE GB SLIDING DOOR D SCHIEBETÜR F PORTE COULISSANTE 	
<p>R03 COD. RA250187</p> <ul style="list-style-type: none"> IT PROFILO COMPENSATORE GB COMPENSATOR PROFILE D AUSGLEICHSPROFIL F PROFIL DE COMPENSATION 		<p>R04 COD. RA250188</p> <ul style="list-style-type: none"> IT PROFILO MONTANTE GB POST PROFILE D FESTPROFIL F PROFIL MONTANT 	
<p>R05 COD. RA250189</p> <ul style="list-style-type: none"> IT PROFILO COVER GB COVER PROFILE D STOPF PROFIL F CACHE 		<p>R06 COD. RA250194</p> <ul style="list-style-type: none"> IT PROFILO MONTANTE GB POST PROFILE D FESTPROFIL F PROFIL MONTANT 	
<p>R07 COD. RA250183</p> <ul style="list-style-type: none"> IT KIT PROFILI CALAMITATI GB PROFILES WITH MAGNET KIT D PROFILES MIT MAGNET KIT F KIT PROFIL AIMANTES 		<p>R08 COD. RA850042</p> <ul style="list-style-type: none"> IT KIT CARRELLI GB SLIDING KIT D GLEITUNGEN KIT F KIT ROULETTE 	
<p>R09 COD. RA100023</p> <ul style="list-style-type: none"> IT SET MANIGLIA R GB HANDLES SET R D HANDGRIFF SET R F KIT POIGNEE R 		<p>R10 COD. RA400100</p> <ul style="list-style-type: none"> IT KIT TAPPI PROFILO GB COVER KIT D STOPF KIT F KIT CACHES PROFIL 	
<p>R11 COD. RA400102</p> <ul style="list-style-type: none"> IT KIT FINECORS A GB SLIDE RAIL STOP KIT D ENDTEIL-KIT DER GLEITSTANGE F KIT BOUTÉE DE FIN DE COURSE 		<p>R12 COD. RA250196</p> <ul style="list-style-type: none"> IT PROFILO BASE SUPERIORE GB TOP BASE PROFILE D OBERES PROFIL F PROFIL BASE SUPERIEURE 	
<p>R13 COD. RA400106</p> <ul style="list-style-type: none"> IT KIT FINECORS A BORBIDI GB SLIDE RAIL STOP KIT THRESHOLD BARS D ENDTEIL-KIT DER GLEITSTANGE SCHWALLSCHUTZLEISTE F KIT BOUTÉE DE FIN DE COURSE BAGUETTE D'ETANCHEITÉ 		<p>R14 COD. RA200022</p> <ul style="list-style-type: none"> IT GUARNIZIONE TRASPARENTE (mt.7) GB TRANSPARENT GASKET (mt.7) D TRANSPARENTE DICHTUNG (mt.7) F JOINT TRANSPARENT (mt.7) 	
<p>R15 COD. RA200176</p> <ul style="list-style-type: none"> IT GUARNIZIONE TRASPARENTE (mt.7) GB TRANSPARENT GASKET (mt.7) D TRANSPARENTE DICHTUNG (mt.7) F JOINT TRANSPARENT (mt.7) 		<p>R16 COD. RA200167</p> <ul style="list-style-type: none"> IT KIT GUARNIZIONI GB GASKET KIT D DICHTUNG KIT F KIT JOINTS 	
<p>R17 COD. RA350115</p> <ul style="list-style-type: none"> IT KIT BORDINO SALVAGOCCIA EN DRIP CATCHER EDGE KIT DE TROPFENFÄNGER PROFIL KIT FR KIT BAGUETTE D'ETANCHEITE 		<p>R18 COD. RA400104</p> <ul style="list-style-type: none"> IT KIT SGANCIO ANTA GB DOOR GLASS RELEASE KIT D SCHNELLEN AUSHÄNGEN DER TÜR F KIT DE DÉCROCHAGE PORTE 	
<p>R19 COD. RA200117</p> <ul style="list-style-type: none"> IT PROFILO SIL (mt.4) GB PROFILE SIL (mt.4) D PROFIL SIL (mt.4) F KIT PROFIL SIL (mt.4) 		<p>R20 COD. RA200168</p> <ul style="list-style-type: none"> IT KIT GUARNIZIONI GB GASKET KIT D DICHTUNG KIT F KIT JOINTS 	

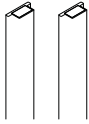
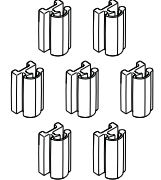
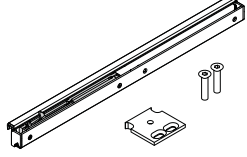

Specificare sempre l'estensibilità, la finitura del profilo, del vetro ed il verso della parete doccia
Please specify always extensibility, profile colour, glass type and opening version of the shower cubicle (R or L)
Verstellbereich, Profilarbe, Glasvariante und Anschlag der Duschkabine (RE o. LI) immer angeben
Toujours spécifier l'extensibilité, la finition du profil, la finition du verre et la version de la paroi de douche (droite ou gauche)

R21 COD. RA200173 IT KIT PROFILI CALAMITATI GB PROFILES WITH MAGNET KIT D PROFILES MIT MAGNET KIT F KIT PROFIL AIMANTES		R22 COD. RA400105 IT KIT TAPPI PROFILO GB COVER KIT D STOPF KIT F KIT CACHES PROFIL	
R23 COD. RA200171 IT KIT GUARNIZIONI GB GASKET KIT D DICHTUNG KIT F KIT JOINTS	R14 + R15 + R16 R19 + R20	R24 COD. RA250248 IT KIT SOFT CLOSE SYSTEM GB SOFT CLOSE SYSTEM KIT D SOFT CLOSE SYSTEM KIT F KIT SYSTÈME SOFT CLOSE	

R25 COD. RA900028 IT KIT FERRAMENTA GB HARDWARE KIT DE EISENWAREN-KIT F KIT QUINCAILLERIE			
 n°4 pz	IT TASSELLO Ø 6mm GB RAWPLUG Ø 6mm DE DÜBEL Ø 6mm F BLOQUER Ø 6mm	 n°4 pz	IT VITE TC 4,2X32 GB SCREW TC 4,2X32 DE SCHRAUBE TC 4,2X32 F VIS TC 4,2X32
 n°8 pz	IT VITE TPSC 2,9X6,5 GB SCREW TPSC 2,9X6,5 DE SCHRAUBE TPSC 2,9X6,5 F VIS TPSC 2,9X6,5	 n°10 pz	IT VITE TC 3,5X9,5 GB SCREW TC 3,5X9,5 DE SCHRAUBE TC 3,5X9,5 F VIS TC 3,5X9,5



Specificare sempre l'estensibilità, la finitura del profilo, del vetro ed il verso della parete doccia
 Please specify always extensibility, profile colour, glass type and opening version of the shower cubicle (R or L)
 Verstellbereich, Profillarbe, Glasvariante und Anschlag der Duschkabine (RE o. LI) immer angeben
 Toujours spécifier l'extensibilité, la finition du profil, la finition du verre et la version de la paroi de douche (droite ou gauche)