

Trattamento protezione vetro
Shower Glass Protect
Glasschutzbehandlung
Traitement protection verre

SGP

TIMELESS

GSS

ESTENSIBILITA' LATO L: L SIDE EXTENSIBILITY: DEHNBARKEIT SEITE L: EXTENSIBILITE CÔTE L:

<input type="checkbox"/> 117,5-118,5	<input type="checkbox"/> 127,5-128,5	<input type="checkbox"/> 137,5-138,5	<input type="checkbox"/> 147,5-148,5	<input type="checkbox"/> 157,5-158,5
<input type="checkbox"/> 167,5-168,5	<input type="checkbox"/> 177,5-178,5	<input type="checkbox"/> 187,5-188,5	<input type="checkbox"/> 197,5-198,5	<input type="checkbox"/> F.M.

ESTENSIBILITA' LATO P: P SIDE EXTENSIBILITY: DEHNBARKEIT SEITE P: EXTENSIBILITE CÔTE P:

<input type="checkbox"/> 67,5-68,5	<input type="checkbox"/> 72,5-73,5	<input type="checkbox"/> 77,5-78,5	<input type="checkbox"/> 82,5-83,5	<input type="checkbox"/> 87,5-88,5
<input type="checkbox"/> 92,5-93,5	<input type="checkbox"/> 97,5-98,5	<input type="checkbox"/> 117,5-118,5	<input type="checkbox"/> 137,5-138,5	<input type="checkbox"/> F.M.

PROFILO: PROFILE: PROFIL: PROFIL:

<input type="checkbox"/> Argento Luc/Silver Brill/Silber Glanz/Argent brillant	<input type="checkbox"/> Alublack	<input type="checkbox"/> RAL opaco/mat/matt-lackiert/mat
<input type="checkbox"/> Metal	<input type="checkbox"/> Metal Brushed	







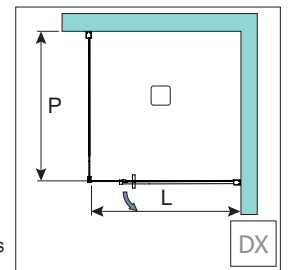
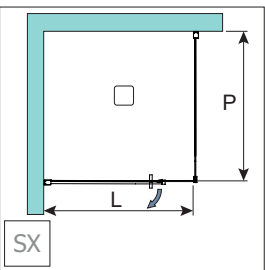

VETRO: GLASS: GLAS: VERRE:

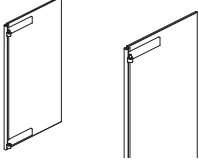
<input type="checkbox"/> Trasparente/Transparent	<input type="checkbox"/> Extra light
<input type="checkbox"/> Piumato/Piumate	<input type="checkbox"/> Vertical Plissé
<input type="checkbox"/> Grigio Europa/Europe grey/Europa grau/gris europe	<input type="checkbox"/> Bronzo Glam/Bronze Glam
<input type="checkbox"/> Specchiato/Mirror effect/Verspiegelter Glas/Effet miroir	<input type="checkbox"/> Satinato/Satin/Satiniert/Satiné
<input type="checkbox"/> Fascia/Band glass/Glas Band/Verre Bonde	<input type="checkbox"/> Serigrafato 3 fasce/Serigraphy 3-bang/Siebdruck 3-Bänder/3 bandes dépolies

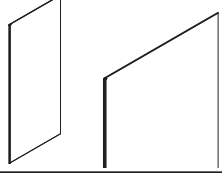
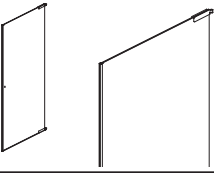
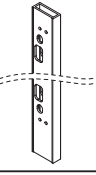
COD. RA900362

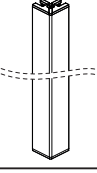
SF Sacchetto Ferramenta
Hardware pack
Rauchchrom
Sachet Quincailleries

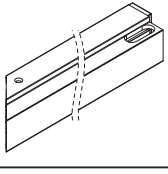
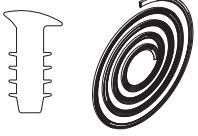
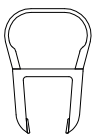
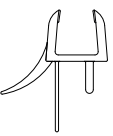
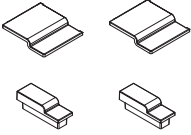
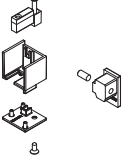

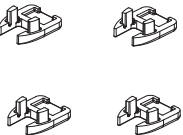
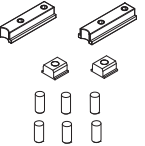
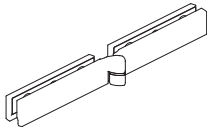
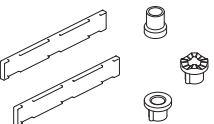



<p>R01 COD. RA300387</p> <ul style="list-style-type: none"> VETRO FISSO FIXED SIDE FIXTEIL CÔTE FIXE 	<p>R02 COD. RA300383</p> <ul style="list-style-type: none"> VETRO FISSO FIXED SIDE FIXTEIL CÔTE FIXE 
<p>R03 COD. RA300384</p> <ul style="list-style-type: none"> VETRO FISSO FIXED SIDE FIXTEIL CÔTE FIXE 	<p>R04 COD. RA300389</p> <ul style="list-style-type: none"> ANTA BATTENTE WING DOOR SCHWENKTÜR PORTE BATTANTE 
<p>R05 COD. RA250525</p> <ul style="list-style-type: none"> PROFILO COMPENSATORE COMPENSATOR PROFILE AUSGLEICHSPROFIL PROFIL DE COMPENSATION 	<p>R06 COD. RA250530</p> <ul style="list-style-type: none"> KIT PROFILO COMPENSATORE COMPENSATOR PROFILE KIT AUSGLEICHSPROFIL PROFIL DE COMPENSATION 
<p>R07 COD. RA250531</p> <ul style="list-style-type: none"> PROFILO COMPENSATORE COMPENSATOR PROFILE AUSGLEICHSPROFIL PROFIL DE COMPENSATION 	<p>R08 COD. RA250522</p> <ul style="list-style-type: none"> KIT PROFILI CALAMITATI PROFILES WITH MAGNET KIT PROFILES MIT MAGNET KIT KIT PROFILS AIMANTES 
<p>R09 COD. RA250491</p> <ul style="list-style-type: none"> KIT PROFILO BASE SUPERIORE TOP BASE PROFILE KIT OBERES PROFIL KIT PROFIL BASE SUPERIEURE 	<p>R10 COD. RA200204</p> <ul style="list-style-type: none"> GUARNIZIONE TRASPARENTE (mt.2,1) TRANSPARENT GASKET (mt.2,1) TRANSPARENTE DICHTUNG (mt.2,1) JOINT TRANSPARENT (mt.2,1) 
<p>R11 COD. RA200115</p> <ul style="list-style-type: none"> PROFILO PVC PROFILE PVC PROFIL AUS PVC PROFIL PVC 	<p>R12 COD. RA200177</p> <ul style="list-style-type: none"> PROFILO PVC PROFILE PVC PROFIL AUS PVC PROFIL PVC 
<p>R13 COD. RA400249</p> <ul style="list-style-type: none"> KIT TAPPI PROFILO COVER KIT STOPF KIT KIT CACHES PROFIL 	<p>R14 COD. RA400264</p> <ul style="list-style-type: none"> KIT TAPPI PROFILO COVER KIT STOPF KIT KIT CACHES PROFIL 
<p>R15 COD. RA400259</p> <ul style="list-style-type: none"> KIT CURVA PROFILO CURVED PROFILE KIT GEBOGENES PROFIL KIT KIT COURBLE PROFIL 	<p>R16 COD. RA400265</p> <ul style="list-style-type: none"> KIT TAPPI PROFILO COVER KIT STOPF KIT KIT CACHES PROFIL 
<p>R17 COD. RA400258</p> <ul style="list-style-type: none"> KIT TAPPI PROFILO COVER KIT STOPF KIT KIT CACHES PROFIL 	<p>R18 COD. RA900356</p> <ul style="list-style-type: none"> KIT RIFERIMENTO PERNO PIVOT-CENTRING-KIT PIVOT-ZENTRIERUNGSKIT KIT CENTRAGE PIVOT 
<p>R19 COD. RA900364</p> <ul style="list-style-type: none"> SET CERNIERA PLUS HINGE DOOR PLUS SET SCHARNIER DER TÜR PLUS SET SET CHARNIÈRE PORTE PLUS 	<p>R20 COD. RA400262</p> <ul style="list-style-type: none"> KIT COVER E BOCCOLE COVER AND BUSHING KIT SET-COVER UND ZYLINDRISCHER RING KIT CACHE ET DOUILLE CYLINDRIQUE 

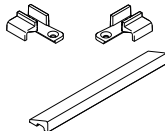
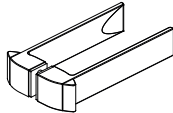
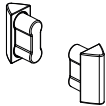

Specificare sempre l'estensibilità, la finitura del profilo, del vetro ed il verso della parete doccia
 Please specify always extensibility, profile colour, glass type and opening version of the shower cubicle (R or L)
 Verstellbereich, Profilfarbe, Glasvariante und Anschlag der Duschkabine (RE o. LI) immer angeben
 Toujours spécifier l'extensibilité, la finition du profil, la finition du verre et la version de la paroi de douche (droite ou gauche)

R21 COD. RA350128 (IT) KIT BORDINO SALVAGOCCIA (EN) DRIP CATCHER EDGE KIT (DE) TROPFENFÄNGER PROFIL KIT (FR) BAGUETTE D'ETANCHEITE		R22 COD. RA100038 (IT) SET MANIGLIA N (EN) HANDLES SET N (DE) HANDGRIFF SET N (FR) KIT POIGNÉE N	
R23 COD. RA400263 (IT) KIT COVER MANIGLIA (EN) HANDLE-COVER-KIT (DE) GRIFF-ABDECKUNG-SET (FR) KIT CACHE POIGNEE			

R24 COD. RA900359 (IT) KIT FERRAMENTA (EN) HARDWARE KIT (DE) EISENWAREN-KIT (FR) KIT QUINCAILLERIE				
 n°04 pz	(IT) TASSELLO Ø 6mm (EN) RAWPLUG Ø 6mm (DE) DÜBEL Ø 6mm (FR) BLOQUER Ø 6mm	 n°04 pz	 n°12 pz	 n°02 pz
	(IT) VITE 4,2X32 TCC (EN) SCREW 4,2X32 TCC (DE) SCHRAUBE 4,2X32 TCC (FR) VIS 4,2X32 TCC	(IT) VITE TPSEI M6X14 (EN) SCREW TPSEI M6X14 (DE) SCHRAUBE TPSEI M6X14 (FR) VIS TPSEI M6X14	(IT) VITE TCEI M4X12 (EN) SCREW TCEI M4X12 (DE) SCHRAUBE TCEI M4X12 (FR) VIS TCEI M4X12	



Specificare sempre l'estensibilità, la finitura del profilo, del vetro ed il verso della parete doccia
 Please specify always extensibility, profile colour, glass type and opening version of the shower cubicle (R or L)
 Verstellbereich, Profilfarbe, Glasvariante und Anschlag der Duschkabine (RE o. LI) immer angeben
 Toujours spécifier l'extensibilité, la finition du profil, la finition du verre et la version de la paroi de douche (droite ou gauche)