

Trattamento protezione vetro  
Shower Glass Protect  
Glasschutzbehandlung  
Traitement protection verre

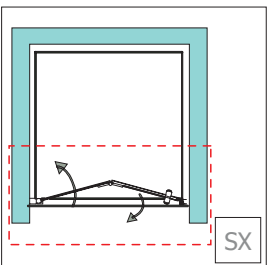

ESTENSIBILITA':	EXTENSIBILITY:	DEHNBARKEIT:	EXTENSIBILITE:
<input type="checkbox"/> 67,5-69,5	<input type="checkbox"/> 72,5-74,5	<input type="checkbox"/> 77,5-79,5	<input type="checkbox"/> 82,5-84,5
<input type="checkbox"/> F.M.			<input type="checkbox"/> 87,5-89,5

PROFILO:	PROFILE:	PROFIL:	PROFIL:
<input type="checkbox"/> Argento Luc/Silver Brill/Silber Glanz/Argent brillant	<input type="checkbox"/> Alublack	<input type="checkbox"/> RAL opaco/mat/matt-lackiert/mat	
<input type="checkbox"/> Metal	<input type="checkbox"/> Metal Brushed		

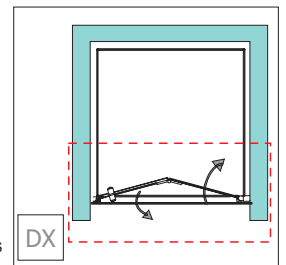
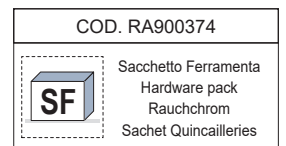

VETRO:	GLASS:	GLAS:	VERRE:
<input type="checkbox"/> Trasparente/Transparent	<input type="checkbox"/> Extra light		
<input type="checkbox"/> Piumato/Piumate	<input type="checkbox"/> Vertical Plissé		
<input type="checkbox"/> Grigio Europa/Europe grey/Europa grau/gris europe	<input type="checkbox"/> Bronzo Glam/Bronze Glam		
<input type="checkbox"/> Specchiato/Mirror effect/Verspiegelter Glas/Effet miroir	<input type="checkbox"/> Satinato/Satin/Satinert/Satiné		
<input type="checkbox"/> Fascia/Band glass/Glas Band/Verre Bonde	<input type="checkbox"/> Serigrafato 3 fasce/Serigraphy 3-bang/Siebdruck 3-Bänder/3 bandes dépolies		

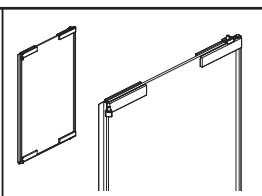
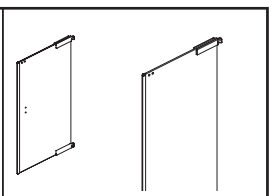
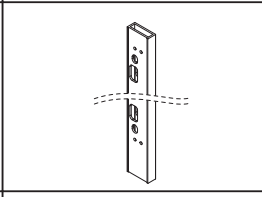
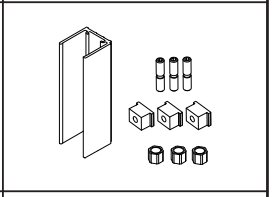
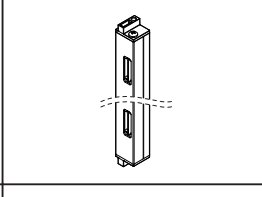
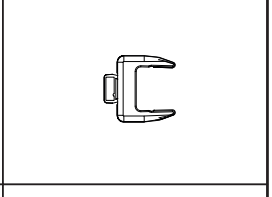
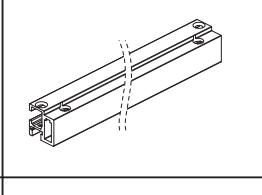
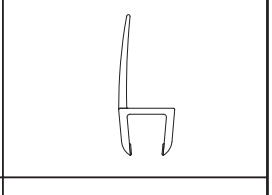
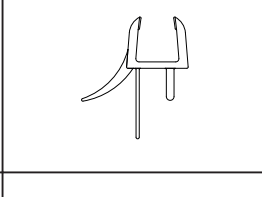
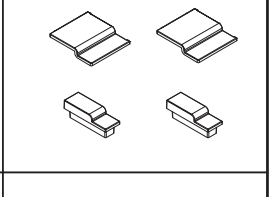
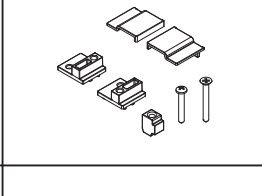
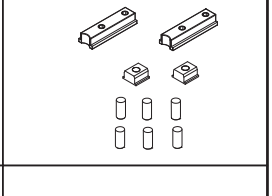
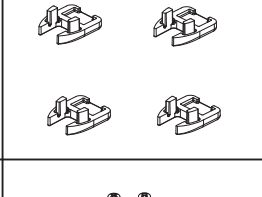
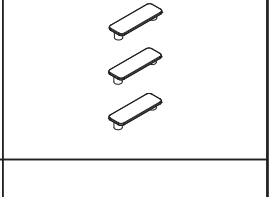
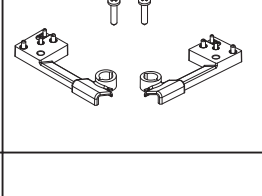
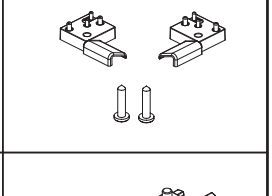
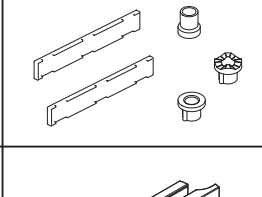
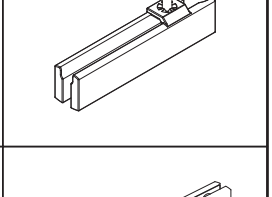
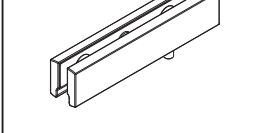
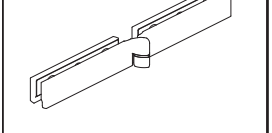



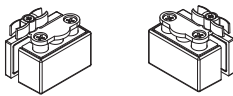
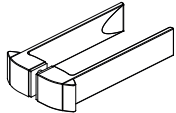
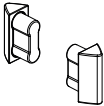

<p><b>R01</b> COD. RA300390</p> <ul style="list-style-type: none"> <li> ANTA PIEGHEVOLE</li> <li> FOLDING DOOR</li> <li> FALTTÜR</li> <li> PORTE PLIANTE</li> </ul> 	<p><b>R02</b> COD. RA300392</p> <ul style="list-style-type: none"> <li> ANTA PIEGHEVOLE</li> <li> FOLDING DOOR</li> <li> FALTTÜR</li> <li> PORTE PLIANTE</li> </ul> 
<p><b>R03</b> COD. RA250525</p> <ul style="list-style-type: none"> <li> PROFILO COMPENSATORE</li> <li> COMPENSATOR PROFILE</li> <li> AUSGLEICHSPROFIL</li> <li> PROFIL DE COMPENSATION</li> </ul> 	<p><b>R04</b> COD. RA250526</p> <ul style="list-style-type: none"> <li> KIT PROFILO COMPENSATORE</li> <li> COMPENSATOR PROFILE KIT</li> <li> AUSGLEICHSPROFIL</li> <li> PROFIL DE COMPENSATION</li> </ul> 
<p><b>R05</b> COD. RA250527</p> <ul style="list-style-type: none"> <li> PROFILO MONTANTE</li> <li> POST PROFILE</li> <li> FESTPROFIL</li> <li> PROFIL MONTANT</li> </ul> 	<p><b>R06</b> COD. RA250523</p> <ul style="list-style-type: none"> <li> KIT PROFILO CALAMITATO</li> <li> PROFILE WITH MAGNET KIT</li> <li> PROFIL MIT MAGNET KIT</li> <li> KIT PROFIL AIMANTE</li> </ul> 
<p><b>R07</b> COD. RA250533</p> <ul style="list-style-type: none"> <li> KIT PROFILO BASE SUPERIORE</li> <li> TOP BASE PROFILE KIT</li> <li> OBERES PROFIL</li> <li> KIT PROFIL BASE SUPERIEURE</li> </ul> 	<p><b>R08</b> COD. RA200283</p> <ul style="list-style-type: none"> <li> PROFILO PVC</li> <li> PROFILE PVC</li> <li> PROFIL AUS PVC</li> <li> PROFIL PVC</li> </ul> 
<p><b>R09</b> COD. RA200177</p> <ul style="list-style-type: none"> <li> PROFILO PVC</li> <li> PROFILE PVC</li> <li> PROFIL AUS PVC</li> <li> PROFIL PVC</li> </ul> 	<p><b>R10</b> COD. RA400249</p> <ul style="list-style-type: none"> <li> KIT TAPPI PROFILO</li> <li> COVER KIT</li> <li> STOPF KIT</li> <li> KIT CACHES PROFIL</li> </ul> 
<p><b>R11</b> COD. RA400257</p> <ul style="list-style-type: none"> <li> KIT TAPPI PROFILO</li> <li> COVER KIT</li> <li> STOPF KIT</li> <li> KIT CACHES PROFIL</li> </ul> 	<p><b>R12</b> COD. RA900356</p> <ul style="list-style-type: none"> <li> KIT RIFERIMENTO PERNO</li> <li> PIVOT-CENTRING-KIT</li> <li> PIVOT-ZENTRIERUNGSKIT</li> <li> KIT CENTRAGE PIVOT</li> </ul> 
<p><b>R13</b> COD. RA400258</p> <ul style="list-style-type: none"> <li> KIT TAPPI PROFILO</li> <li> COVER KIT</li> <li> STOPF KIT</li> <li> KIT CACHES PROFIL</li> </ul> 	<p><b>R14</b> COD. RA400260</p> <ul style="list-style-type: none"> <li> KIT TAPPI PROFILO</li> <li> COVER KIT</li> <li> STOPF KIT</li> <li> KIT CACHES PROFIL</li> </ul> 
<p><b>R15</b> COD. RA400261</p> <ul style="list-style-type: none"> <li> KIT BASSETTE INFERIORI</li> <li> BOTTOM PLUGS KIT</li> <li> UNTERES STOPFEN-KIT</li> <li> KIT CACHES INFÉRIEURES</li> </ul> 	<p><b>R16</b> COD. RA400267</p> <ul style="list-style-type: none"> <li> KIT TAPPI PROFILO</li> <li> COVER KIT</li> <li> STOPF KIT</li> <li> KIT CACHES PROFIL</li> </ul> 
<p><b>R17</b> COD. RA400262</p> <ul style="list-style-type: none"> <li> KIT COVER E BOCCOLE</li> <li> COVER AND BUSHING KIT</li> <li> SET-COVER UND ZYLINDRISCHER RING</li> <li> KIT CACHE ET DOUILLE CYLINDRIQUE</li> </ul> 	<p><b>R18</b> COD. RA900357</p> <ul style="list-style-type: none"> <li> KIT CERNIERA SUPERIORE</li> <li> UPPER HINGE KIT</li> <li> SET OBERE SCHARNIERE</li> <li> KIT CHARNIÈRE SUPÉRIEURE</li> </ul> 
<p><b>R19</b> COD. RA900358</p> <ul style="list-style-type: none"> <li> KIT CERNIERA INFERIORE</li> <li> BOTTOM HINGE KIT</li> <li> SET UNTERE SCHARNIERE</li> <li> KIT CHARNIÈRE INFÉRIEURE</li> </ul> 	<p><b>R20</b> COD. RA900364</p> <ul style="list-style-type: none"> <li> SET CERNIERA PLUS</li> <li> HINGE DOOR PLUS SET</li> <li> SCHARNIER DER TÜR PLUS SET</li> <li> SET CHARNIÈRE PORTE PLUS</li> </ul> 



Specificare sempre l'estensibilità, la finitura del profilo, del vetro ed il verso della parete doccia  
 Please specify always extensibility, profile colour, glass type and opening version of the shower cubicle (R or L)  
 Verstellbereich, Profilfarbe, Glasvariante und Anschlag der Duschkabine (RE o. LI) immer angeben  
 Toujours spécifier l'extensibilité, la finition du profil, la finition du verre et la version de la paroi de douche (droite ou gauche)

<p>R21 COD. RA400266</p> <ul style="list-style-type: none"> <li> KIT SGANCIO ANTA</li> <li> DOOR GLASS RELEASE KIT</li> <li> SCHNELLEN AUSHÄNGEN DER TÜR</li> <li> KIT DE DÉCROCHAGE PORTE</li> </ul>		<p>R22 COD. RA100038</p> <ul style="list-style-type: none"> <li> SET MANIGLIA N</li> <li> HANDLES SET N</li> <li> HANDGRIFF SET N</li> <li> KIT POIGNÉE N</li> </ul>	
<p>R23 COD. RA400263</p> <ul style="list-style-type: none"> <li> KIT COVER MANIGLIA</li> <li> HANDLE-COVER-KIT</li> <li> GRIFF-ABDECKUNG-SET</li> <li> KIT CACHE POIGNEE</li> </ul>		<p>R24 COD. RA350038</p> <ul style="list-style-type: none"> <li> BORDINO SALVAGOCCIA</li> <li> DRIP CATCHER EDGE</li> <li> TROPFENFÄNGER PROFIL</li> <li> BAGUETTE D'ETANCHEITE</li> </ul>	

<p>R25 COD. RA900377  KIT FERRAMENTA  HARDWARE KIT  EISENWAREN-KIT  KIT QUINCAILLERIE</p>			
 <ul style="list-style-type: none"> <li> TASSELLO Ø 6mm</li> <li> RAWPLUG Ø 6mm</li> <li> DÜBEL Ø 6mm</li> <li> BLOQUER Ø 6mm</li> </ul> <p>n°04 pz</p>	 <ul style="list-style-type: none"> <li> VITE 4,2X32 TCC</li> <li> SCREW 4,2X32 TCC</li> <li> SCHRAUBE 4,2X32 TCC</li> <li> VIS 4,2X32 TCC</li> </ul> <p>n°04 pz</p>	 <ul style="list-style-type: none"> <li> VITE TPSEI M6X14</li> <li> SCREW TPSEI M6X14</li> <li> SCHRAUBE TPSEI M6X14</li> <li> VIS TPSEI M6X14</li> </ul> <p>n°18 pz</p>	 <ul style="list-style-type: none"> <li> VITE TCEI M4X12</li> <li> SCREW TCEI M4X12</li> <li> SCHRAUBE TCEI M4X12</li> <li> VIS TCEI M4X12</li> </ul> <p>n°01 pz</p>



Specificare sempre l'estensibilità, la finitura del profilo, del vetro ed il verso della parete doccia  
 Please specify always extensibility, profile colour, glass type and opening version of the shower cubicle (R or L)  
 Verstellbereich, Profilfarbe, Glasvariante und Anschlag der Duschkabine (RE o. LI) immer angeben  
 Toujours spécifier l'extensibilité, la finition du profil, la finition du verre et la version de la paroi de douche (droite ou gauche)