

Trattamento protezione vetro  
Shower Glass Protect  
Glasschutzbehandlung  
Traitement protection verre

SGP

TIMELESS

GSS

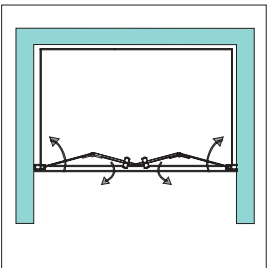

ESTENSIBILITA':	EXTENSIBILITY:	DEHNBARKEIT:	EXTENSIBILITE:
<input type="checkbox"/> 117,5-119,5	<input type="checkbox"/> 127,5-129,5	<input type="checkbox"/> 137,5-139,5	<input type="checkbox"/> 147,5-149,5
<input type="checkbox"/> 167,5-169,5	<input type="checkbox"/> 177,5-179,5	<input type="checkbox"/> F.M. _____	<input type="checkbox"/> 157,5-159,5

PROFILO:	PROFILE:	PROFIL:	PROFIL:
<input type="checkbox"/> Argento Luc/Silver Brill/Silber Glanz/Argent brillant	<input type="checkbox"/> Alublack	<input type="checkbox"/> RAL opaco/mat/matt-lackiert/mat	
<input type="checkbox"/> Metal	<input type="checkbox"/> Metal Brushed		

VETRO:	GLASS:	GLAS:	VERRE:
<input type="checkbox"/> Trasparente/Transparent	<input type="checkbox"/> Extra light		
<input type="checkbox"/> Piumato/Piumate	<input type="checkbox"/> Vertical Plissé		
<input type="checkbox"/> Grigio Europa/Europe grey/Europa grau/gris europe	<input type="checkbox"/> Bronzo Glam/Bronze Glam		
<input type="checkbox"/> Specchiato/Mirror effect/Verspiegelter Glas/Effet miroir	<input type="checkbox"/> Satinato/Satin/Satinert/Satiné		
<input type="checkbox"/> Fascia/Band glass/Glas Band/Verre Bonde	<input type="checkbox"/> Serigrafato 3 fasce/Serigraphy 3-bang/Siebdruck 3-Bänder/3 bandes dépolies		

COD. RA900375



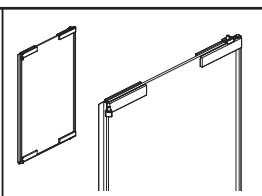
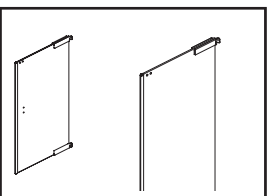
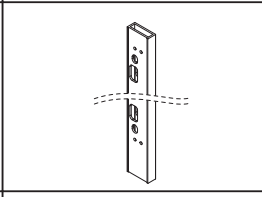
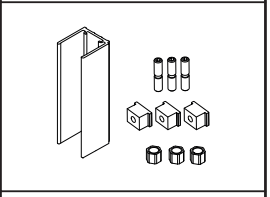
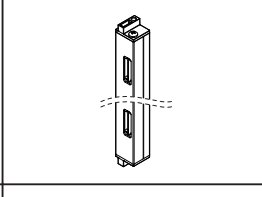
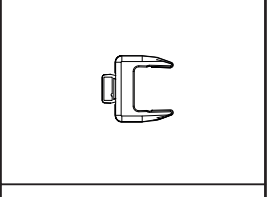
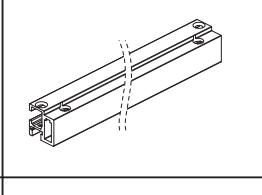
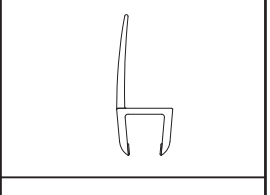
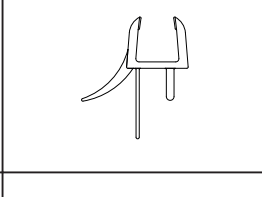
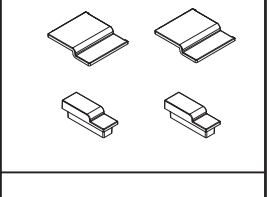
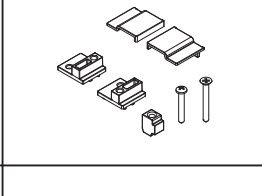
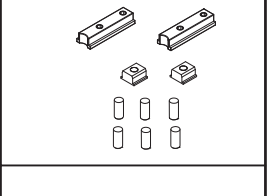
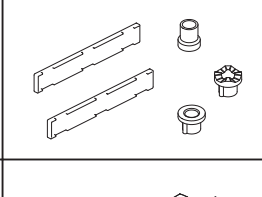
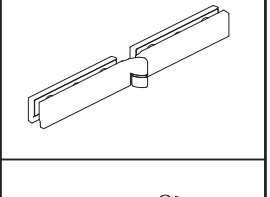
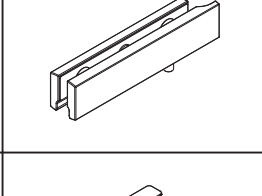
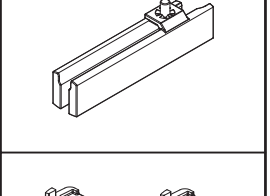
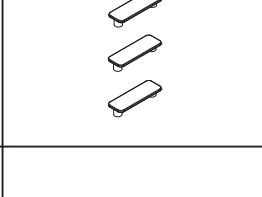
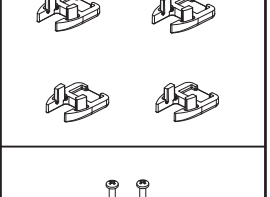
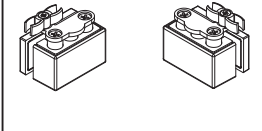
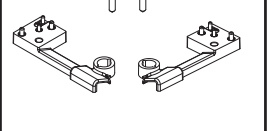

**SF** Sacchetto Ferramenta  
Hardware pack  
Rauchchrom  
Sachet Quincailleries

<p>R01 COD. RA300390</p> <ul style="list-style-type: none"> <li> ANTA PIEGHEVOLE</li> <li> FOLDING DOOR</li> <li> FALTTÜR</li> <li> PORTE PLIANTE</li> </ul> 	<p>R02 COD. RA300392</p> <ul style="list-style-type: none"> <li> ANTA PIEGHEVOLE</li> <li> FOLDING DOOR</li> <li> FALTTÜR</li> <li> PORTE PLIANTE</li> </ul> 
<p>R03 COD. RA250525</p> <ul style="list-style-type: none"> <li> PROFILO COMPENSATORE</li> <li> COMPENSATOR PROFILE</li> <li> AUSGLEICHSPROFIL</li> <li> PROFIL DE COMPENSATION</li> </ul> 	<p>R04 COD. RA250526</p> <ul style="list-style-type: none"> <li> KIT PROFILO COMPENSATORE</li> <li> COMPENSATOR PROFILE KIT</li> <li> AUSGLEICHSPROFIL</li> <li> PROFIL DE COMPENSATION</li> </ul> 
<p>R05 COD. RA250527</p> <ul style="list-style-type: none"> <li> PROFILO MONTANTE</li> <li> POST PROFILE</li> <li> FESTPROFIL</li> <li> PROFIL MONTANT</li> </ul> 	<p>R06 COD. RA250523</p> <ul style="list-style-type: none"> <li> KIT PROFILO CALAMITATO</li> <li> PROFILE WITH MAGNET KIT</li> <li> PROFIL MIT MAGNET KIT</li> <li> KIT PROFIL AIMANTE</li> </ul> 
<p>R07 COD. RA250533</p> <ul style="list-style-type: none"> <li> KIT PROFILO BASE SUPERIORE</li> <li> TOP BASE PROFILE KIT</li> <li> OBERES PROFIL</li> <li> KIT PROFIL BASE SUPERIEURE</li> </ul> 	<p>R08 COD. RA200283</p> <ul style="list-style-type: none"> <li> PROFILO PVC</li> <li> PROFILE PVC</li> <li> PROFIL AUS PVC</li> <li> PROFIL PVC</li> </ul> 
<p>R09 COD. RA200177</p> <ul style="list-style-type: none"> <li> PROFILO PVC</li> <li> PROFILE PVC</li> <li> PROFIL AUS PVC</li> <li> PROFIL PVC</li> </ul> 	<p>R10 COD. RA400249</p> <ul style="list-style-type: none"> <li> KIT TAPPI PROFILO</li> <li> COVER KIT</li> <li> STOPF KIT</li> <li> KIT CACHES PROFIL</li> </ul> 
<p>R11 COD. RA400257</p> <ul style="list-style-type: none"> <li> KIT TAPPI PROFILO</li> <li> COVER KIT</li> <li> STOPF KIT</li> <li> KIT CACHES PROFIL</li> </ul> 	<p>R12 COD. RA900356</p> <ul style="list-style-type: none"> <li> KIT RIFERIMENTO PERNO</li> <li> PIVOT-CENTRING-KIT</li> <li> PIVOT-ZENTRIERUNGSKIT</li> <li> KIT CENTRAGE PIVOT</li> </ul> 
<p>R13 COD. RA400262</p> <ul style="list-style-type: none"> <li> KIT COVER E BOCCOLE</li> <li> COVER AND BUSHING KIT</li> <li> SET-COVER UND ZYLINDRISCHER RING</li> <li> KIT CACHE ET DOUILLE CYLINDRIQUE</li> </ul> 	<p>R14 COD. RA900364</p> <ul style="list-style-type: none"> <li> SET CERNIERA PLUS</li> <li> HINGE DOOR PLUS SET</li> <li> SCHARNIER DER TÜR PLUS SET</li> <li> SET CHARNIÈRE PORTE PLUS</li> </ul> 
<p>R15 COD. RA900358</p> <ul style="list-style-type: none"> <li> KIT CERNIERA INFERIORE</li> <li> BOTTOM HINGE KIT</li> <li> SET UNTERE SCHARNIERE</li> <li> KIT CHARNIÈRE INFÉRIEURE</li> </ul> 	<p>R16 COD. RA900357</p> <ul style="list-style-type: none"> <li> KIT CERNIERA SUPERIORE</li> <li> UPPER HINGE KIT</li> <li> SET OBERE SCHARNIERE</li> <li> KIT CHARNIÈRE SUPÉRIEURE</li> </ul> 
<p>R17 COD. RA400260</p> <ul style="list-style-type: none"> <li> KIT TAPPI PROFILO</li> <li> COVER KIT</li> <li> STOPF KIT</li> <li> KIT CACHES PROFIL</li> </ul> 	<p>R18 COD. RA400258</p> <ul style="list-style-type: none"> <li> KIT TAPPI PROFILO</li> <li> COVER KIT</li> <li> STOPF KIT</li> <li> KIT CACHES PROFIL</li> </ul> 
<p>R19 COD. RA400266</p> <ul style="list-style-type: none"> <li> KIT SGANCIO ANTA</li> <li> DOOR GLASS RELEASE KIT</li> <li> SCHNELLEN AUSHÄNGEN DER TÜR</li> <li> KIT DE DÉCROCHAGE PORTE</li> </ul> 	<p>R20 COD. RA400261</p> <ul style="list-style-type: none"> <li> KIT BASSETTE INFERIORI</li> <li> BOTTOM PLUGS KIT</li> <li> UNTERES STOPFEN-KIT</li> <li> KIT CACHES INFÉRIEURES</li> </ul> 

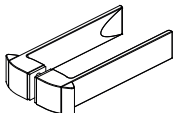
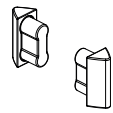
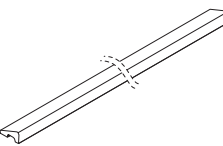
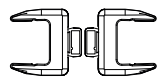

Specificare sempre l'estensibilità, la finitura del profilo, del vetro ed il verso della parete doccia  
 Please specify always extensibility, profile colour, glass type and opening version of the shower cubicle (R or L)  
 Verstellbereich, Profilfarbe, Glasvariante und Anschlag der Duschkabine (RE o. LI) immer angeben  
 Toujours spécifier l'extensibilité, la finition du profil, la finition du verre et la version de la paroi de douche (droite ou gauche)

<p>R21 COD. RA100038</p> <ul style="list-style-type: none"> <li> SET MANIGLIA N</li> <li> HANDLES SET N</li> <li> HANDGRIFF SET N</li> <li> KIT POIGNÉE N</li> </ul>		<p>R22 COD. RA400263</p> <ul style="list-style-type: none"> <li> KIT COVER MANIGLIA</li> <li> HANDLE-COVER-KIT</li> <li> GRIFF-ABDECKUNG-SET</li> <li> KIT CACHE POIGNEE</li> </ul>	
<p>R23 COD. RA350039</p> <ul style="list-style-type: none"> <li> BORDINO SALVAGOCCIA</li> <li> DRIP CATCHER EDGE</li> <li> TROPFENFÄNGER PROFIL</li> <li> BAGUETTE D'ETANCHEITE</li> </ul>		<p>R24 COD. RA250524</p> <ul style="list-style-type: none"> <li> KIT PROFILO CALAMITATO</li> <li> PROFILE WITH MAGNET KIT</li> <li> PROFIL MIT MAGNET KIT</li> <li> KIT PROFIL AIMANTE</li> </ul>	

<p>R25 COD. RA900377  KIT FERRAMENTA  HARDWARE KIT  EISENWAREN-KIT  KIT QUINCAILLERIE</p>			
 <ul style="list-style-type: none"> <li> TASSELLO Ø 6mm</li> <li> RAWPLUG Ø 6mm</li> <li> DÜBEL Ø 6mm</li> <li> BLOQUER Ø 6mm</li> </ul> <p>n°04 pz</p>	 <ul style="list-style-type: none"> <li> VITE 4,2X32 TCC</li> <li> SCREW 4,2X32 TCC</li> <li> SCHRAUBE 4,2X32 TCC</li> <li> VIS 4,2X32 TCC</li> </ul> <p>n°04 pz</p>	 <ul style="list-style-type: none"> <li> VITE TPSEI M6X14</li> <li> SCREW TPSEI M6X14</li> <li> SCHRAUBE TPSEI M6X14</li> <li> VIS TPSEI M6X14</li> </ul> <p>n°18 pz</p>	 <ul style="list-style-type: none"> <li> VITE TCEI M4X12</li> <li> SCREW TCEI M4X12</li> <li> SCHRAUBE TCEI M4X12</li> <li> VIS TCEI M4X12</li> </ul> <p>n°01 pz</p>



Specificare sempre l'estensibilità, la finitura del profilo, del vetro ed il verso della parete doccia  
 Please specify always extensibility, profile colour, glass type and opening version of the shower cubicle (R or L)  
 Verstellbereich, Profilfarbe, Glasvariante und Anschlag der Duschkabine (RE o. LI) immer angeben  
 Toujours spécifier l'extensibilité, la finition du profil, la finition du verre et la version de la paroi de douche (droite ou gauche)